

EEV-EX14 A1.1

EEV-EX14 COM Express Type 6 Evaluation Carrier Board

User's Manual



1st Ed – 30 August 2017

Contents

1.	Getting Started	4
1.1	Safety Precautions	4
1.2	Packing List	4
2.	Hardware Configuration	5
2.1	Product Overview	6
2.2	Jumper and Connector List.....	7
2.3	Setting Jumpers & Connectors	10
2.3.1	Clear CMOS (JBAT1)	10
2.3.2	S3 signal selector (JPWR1).....	10
2.3.3	PCIE signal selector (JPCIE1)	11
2.3.4	PCIE2 (DDI) signal selector (JHDMI1)	11
2.3.5	COM1 Pin 9 signal select (JRI1)	12
2.3.6	SUPER I/O Address select (JSIO1)	12
2.3.7	AT Power selector (JAT1)	13
2.3.8	ATX1 Power connector (ATX1)	13
2.3.9	ATX2 Power connector (ATX2).....	14
2.3.10	CPU Fan connector/ System Fan connector 1/ System Fan connector 2	14
2.3.11	Floppy connector 1 (FDC1)	15
2.3.12	Printer connector (JPRT1).....	16
2.3.13	IR connector (JIR1)	16
2.3.14	Serial Port 2 RS422/485 connector (J422/485)	17
2.3.15	Serial Port 2 RS232 connector (JCOM2)	17
2.3.16	General Purpose I/O connector (JDIO1)	18
2.3.17	Multi-purpose connector (JCN3)	18
2.3.18	Front panel connector (JFP1).....	19
2.3.19	SPI selector (JSPI1)	19
2.3.20	Carrier board SPI FLASH programming (JSPI2)	20
2.3.21	LCD backlight brightness adjustment connector (JVR1).....	20
2.3.22	LCD Inverter connector (JBKL1)	21
	2.3.22.1 Signal Description – LCD Inverter connector (JBKL1)	21
2.3.23	LVDS connector (LVDS1).....	22
2.3.24	USB Connector 4 & 5 (JUSB1)	22
2.3.25	LPC port connector (JLPC1)	23
2.3.26	SPDIF connector (JSPDIF1)	23
2.3.27	CD-ROM Audio Input connector (JCD1)	24
2.3.28	7.1ch Audio connector (JAUDIO1)	24

2.3.29	Front Audio connector (JAUDIO2)	25
2.3.30	Battery connector (BH1)	25
2.3.31	EDP connector (EDP1).....	26
2.4	EEV-EX14 Expansion Boards	27
2.4.1	Product Overview	27
2.4.2	Jumper and Connector List	28
2.5	EEV-EX14 Expansion Boards Setting	29
2.5.1	Audio Expansion Card for Front Audio (KJAUDIO1).....	29
2.5.2	Audio Expansion Card for 7.1ch Audio (KJAUDIO2)	29

1. Getting Started

1.1 Safety Precautions

Warning!



Always completely disconnect the power cord from your chassis whenever you work with the hardware. Do not make connections while the power is on. Sensitive electronic components can be damaged by sudden power surges. Only experienced electronics personnel should open the PC chassis.

Caution!



Always ground yourself to remove any static charge before touching the CPU card. Modern electronic devices are very sensitive to static electric charges. As a safety precaution, use a grounding wrist strap at all times. Place all electronic components in a static-dissipative surface or static-shielded bag when they are not in the chassis.

1.2 Packing List

Before you begin installing your single board, please make sure that the following materials have been shipped:

- 1 x EEV-EX14 COM Express Type 6 Evaluation Carrier Board.
- 1 x DVD-ROM contains the followings:
 - Audio drivers and utilities



If any of the above items is damaged or missing, contact your retailer.

2. Hardware Configuration

2.1 Product Overview

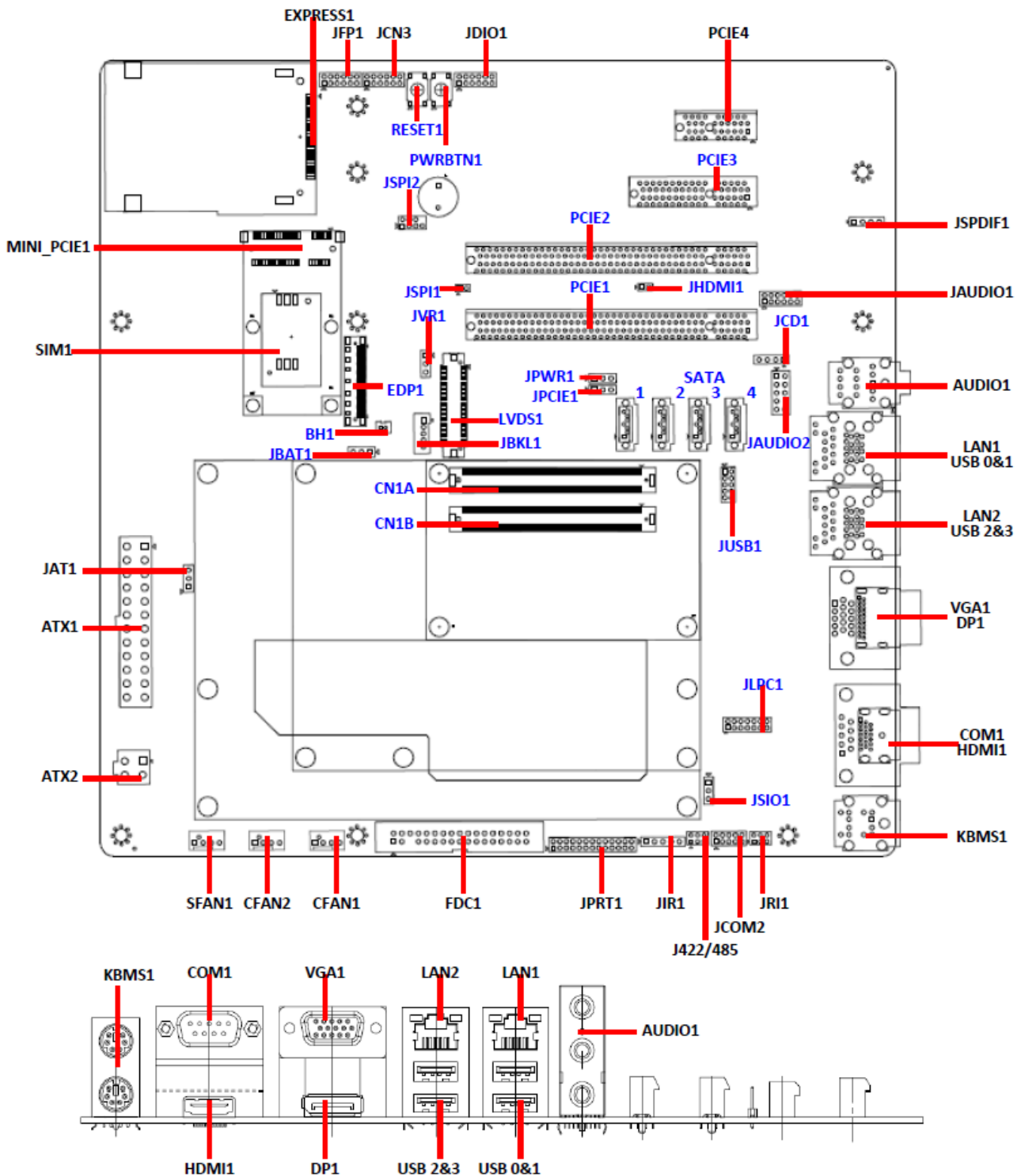

2.2 Jumper and Connector List

You can configure your board to match the needs of your application by setting jumpers. A jumper is the simplest kind of electric switch.

It consists of two metal pins and a small metal clip (often protected by a plastic cover) that slides over the pins to connect them. To “close” a jumper you connect the pins with the clip. To “open” a jumper you remove the clip. Sometimes a jumper will have three pins, labeled 1, 2, and 3. In this case, you would connect either two pins.

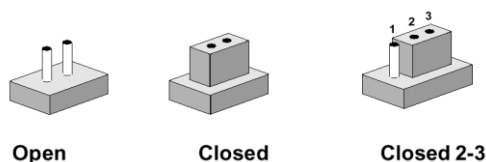

The jumper settings are schematically depicted in this manual as follows:



A pair of needle-nose pliers may be helpful when working with jumpers.

Connectors on the board are linked to external devices such as hard disk drives, a keyboard, or floppy drives. In addition, the board has a number of jumpers that allow you to configure your system to suit your application.

If you have any doubts about the best hardware configuration for your application, contact your local distributor or sales representative before you make any changes.

The following tables list the function of each of the board's jumpers and connectors.

Jumpers

Label	Function	Note
JAT1	12V control selector	3 x 1 header, pitch 2.54mm
JBAT1	Clear CMOS	3 x 1 header, pitch 2.54mm
JPWR1	S3 signal control selector	3 x 1 header, pitch 2.54mm
JPCIE1	PCIE signal selector	3 x 1 header, pitch 2.54mm
JHDMI1	PCIE2 (DDI) signal selector	2 x 1 header, pitch 2.00mm
JRI1	COM1 pin 9 signal select	3 x 2 header, pitch 2.00mm
JSIO1	SUPER I/O Address select	3 x 1 header, pitch 2.54mm

Connectors

Label	Function	Note
AUDIO1	Audio connector	
ATX1	ATX1 Power connector	12 x 2 wafer, pitch 4.2mm
ATX2	ATX2 Power connector	2 x 2 wafer, pitch 4.2mm
COM1	Serial port 1 connector	D-Sub 9 pin
CFAN1	CPU fan connector 1	4 x 1 wafer
CFAN2	CPU fan connector 2	4 x 1 wafer
DP1	Display port connector	
EXPRESS1	Express card connector	
FDC1	Floppy connector 1	17 x 2 wafer box, pitch 2.54 mm
HDMI1	HDMI connector 1	
JAUDIO1	7.1ch Audio connector	6 x 2 header, pitch 2.00mm
JPRT1	Printer connector	13 x 2 header, pitch 2.00mm
JIR1	IR connector	5 x 1 header, pitch 2.00mm
JSPDIF1	SPDIF connector	4 x 1 header, pitch 2.54mm
J422/485	Serial Port 2 RS422/485 connector	3 x 2 header, pitch 2.00mm
JCOM2	Serial Port 2 RS232 connector	5 x 2 header, pitch 2.00mm
KBMS1	KB/MS connector	
LAN1/2	Ethernet connector	
MINI-PCIE1	PCI Express Mini Card slot	
JDIO1	DIO connector	6 x 2 header, pitch 2.00mm
JCN3	Multi-purpose connector	6 x 2 header, pitch 2.00mm
JFP1	Front panel connector	6 x 2 header, pitch 2.00mm
JSPI1	SPI Selector	2 x 1 header, pitch 2.00mm
SIM1	SIM card slot	
PWRBTN1	Power button	
RESET1	Reset button	
SFAN1	System fan connector	4 x 1 wafer
USB 0&1	USB connector 0&1	
USB 2&3	USB connector 2&3	
VGA1	VGA connector	
JSPI2	Carrier board SPI FLASH programming	4 x 2 header, pitch 2.00mm
JVR1	LCD backlight brightness adjustment	3 x 1 header, pitch 2.54mm

	connector	
PCIE1	PCI Express x16 connector	PCIEXPRESS_164V
PCIE2	Digital Display Interfaces (DDI) slot	PCIEXPRESS_164V
PCIE3	PCI Express x4 connector	PCIEXPRESS_64V
PCIE4	PCI Express x1 connector	PCIEXPRESS_36V
JCD1	CD-ROM Audio Input connector	4 x 1 wafer, pitch 2.54mm
SATA 1/2/3/4	Serial ATA connector	
JAUDIO2	Front Audio connector	5 x 2 wafer, pitch 2.54mm
LVDS1	LVDS connector	20 x 2 box header, pitch 1.25 mm Matching Connector: Hirose DF13-40DS-1.25C
JBKL1	LCD Inverter connector	5 x 1 wafer, pitch 2.00mm Matching Connector: JST PHR-5
CN1A	COM Express connector A	
CN1B	COM Express connector B	
JUSB1	USB 4&5 connector	5 x 2 header, pitch 2.00mm
JLPC1	LPC port connector	7 x 2 header, pitch 2.00mm
EDP1	EDP connector	DIN 44-pin wafer, pitch 0.50mm
BH1	Battery connector	2 x 1 wafer, pitch 1.25mm

2.3 Setting Jumpers & Connectors

2.3.1 Clear CMOS (JBAT1)

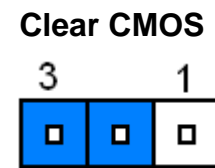
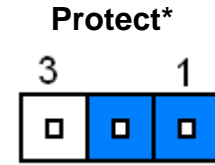
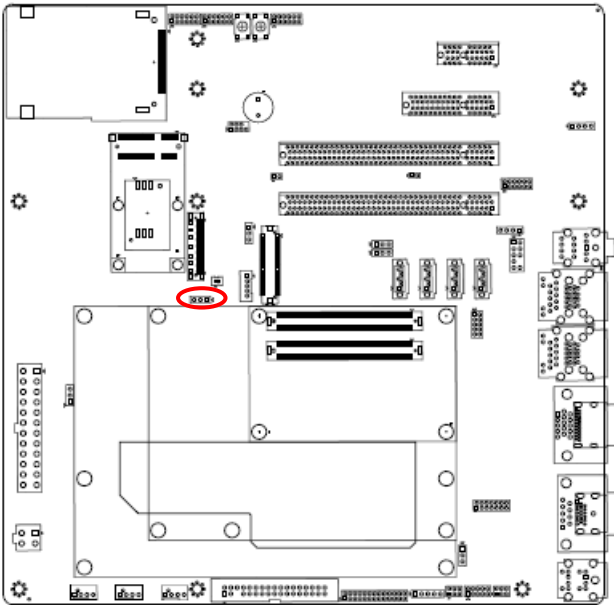

* Default

2.3.2 S3 signal selector (JPWR1)

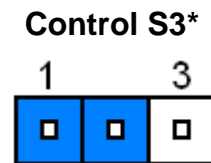
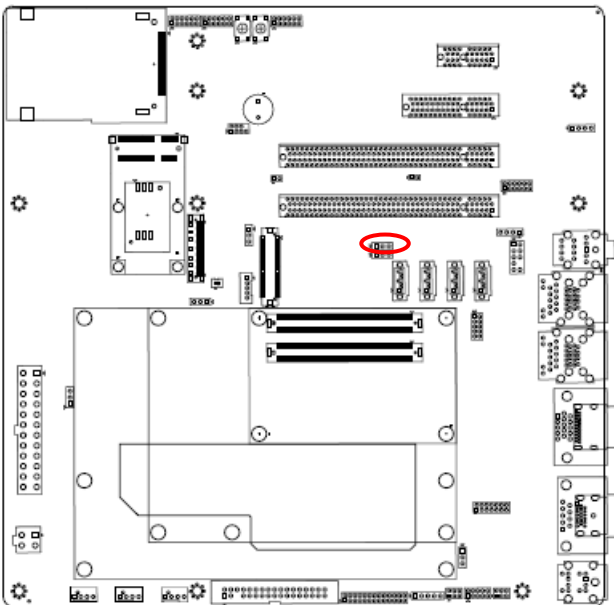

NO Control of S3

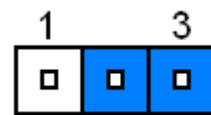

* Default

Note:

PIN1(Input) : Control by power button

PIN2(Output) : Control power IC

PIN3(Input) : Module board to Carrier board signal

Signal	PIN
PWR_S3	1
S3	2
SLP_S3#	3

2.3.3 PCIE signal selector (JPCIE1)

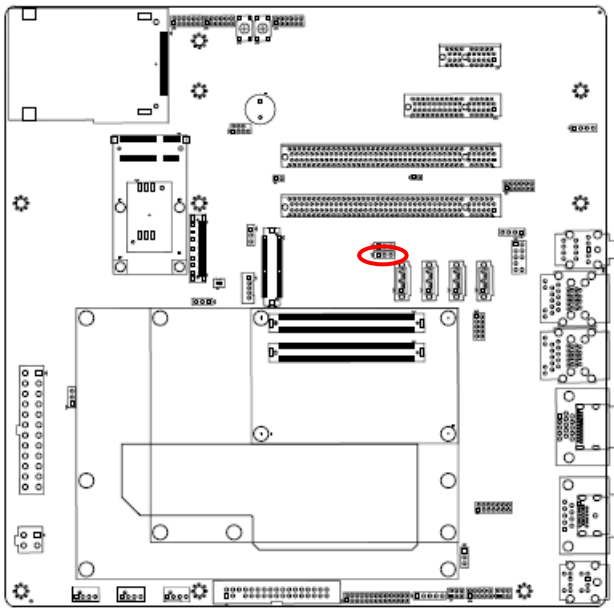

Default*

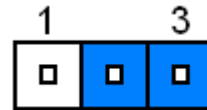
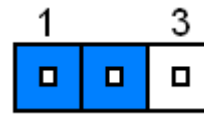

Signal	PIN
GND	1
SEL	2
+3.3V	3

PCI Express Differential Transmit Pairs

JPCIE1	PCIE [0]	PCIE [1]	PCIE [2]	PCIE [3]	PCIE [4]	PCIE [5]	PCIE [6]	PCIE [7]
SEL=LOW	PCIE3				LAN2	PCIE4	MIIN-PCIE1	EXPRESS1
SEL=HIGH	LAN2	PCIE4	MIIN-PCIE1	EXPRESS1	X	X	X	X

2.3.4 PCIE2 (DDI) signal selector (JHDMI1)

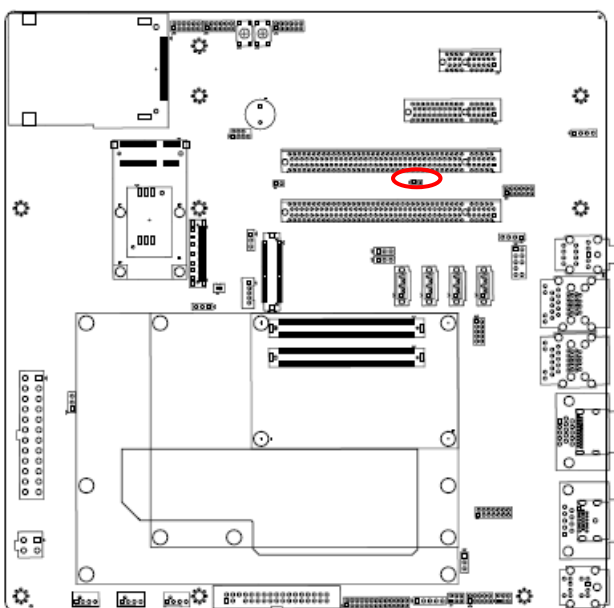

HDMI/SDVO*

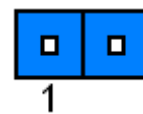

Display Port

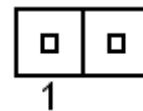

Signal	PIN
+3.3V	1
DDI_DDC_AUX_SEL	2

*Default

2.3.5 COM1 Pin 9 signal select (JRI1)

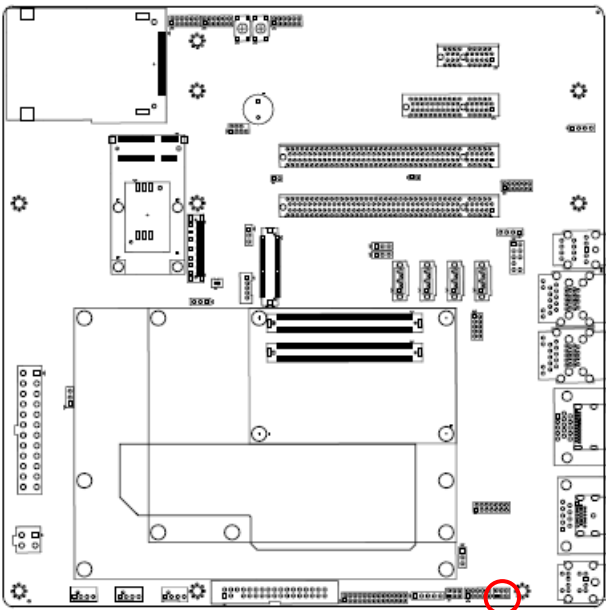

*Default

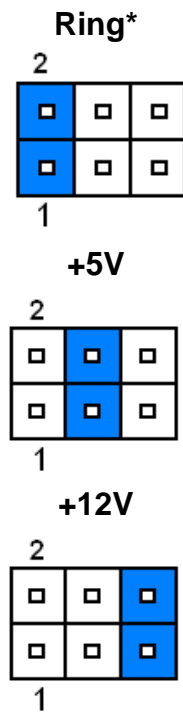

2.3.6 SUPER I/O Address select (JSIO1)

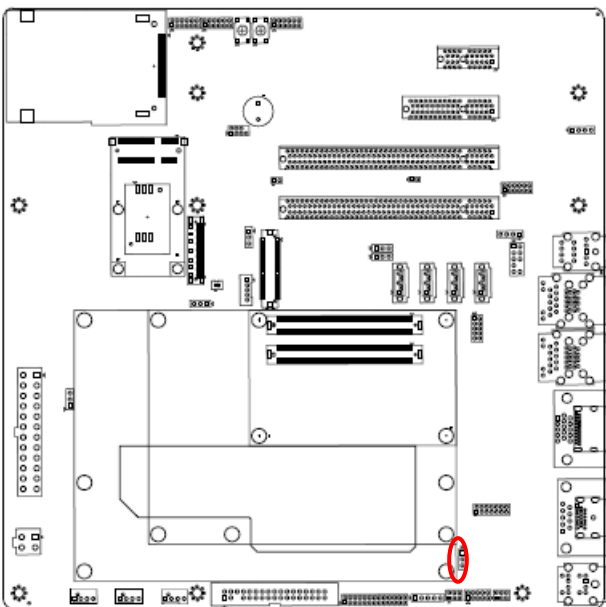

*Default

High: 4Eh/4Fh

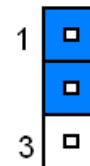

Low: 2Eh/2Fh*

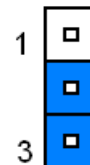

Signal	PIN
+3.3V	1
RTSA#	2
GND	1

2.3.7 AT Power selector (JAT1)

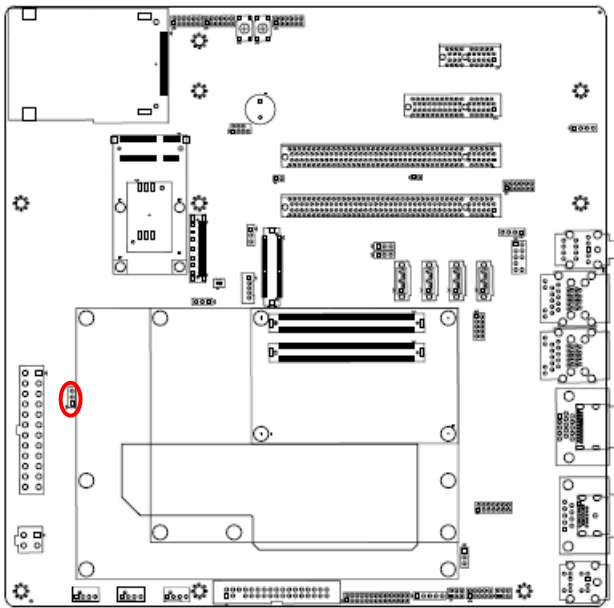

12V Control*

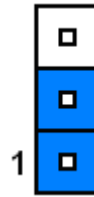

12V Always

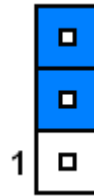

Signal	PIN
SLP_S3#	1
Enable +12V	2
+3VSB	3

*Default

Note:

When jumper 2-3 closed : Module board always have +12V

2.3.8 ATX1 Power connector (ATX1)

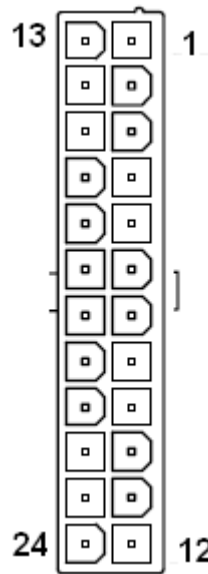
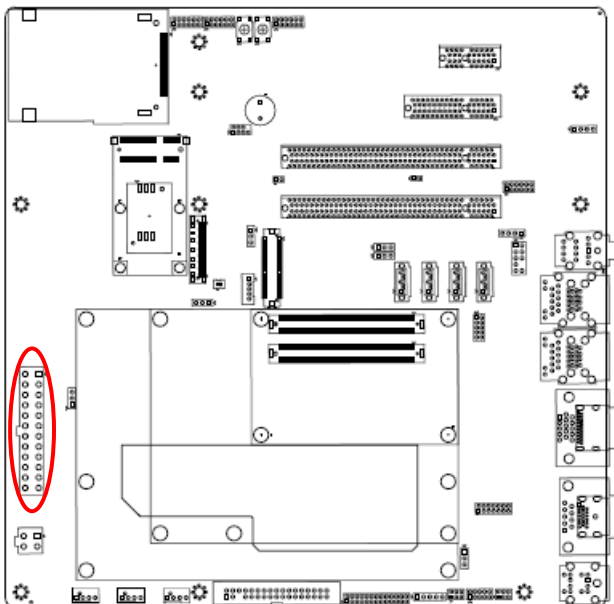

Signal	PIN	PIN	Signal
NC	13	1	NC
NC	14	2	NC
GND	15	3	GND
PSON#	16	4	NC
GND	17	5	GND
GND	18	6	NC
GND	19	7	GND
NC	20	8	NC
NC	21	9	+5VSB
NC	22	10	+12V
NC	23	11	+12V
GND	24	12	NC

2.3.9 ATX2 Power connector (ATX2)

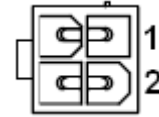
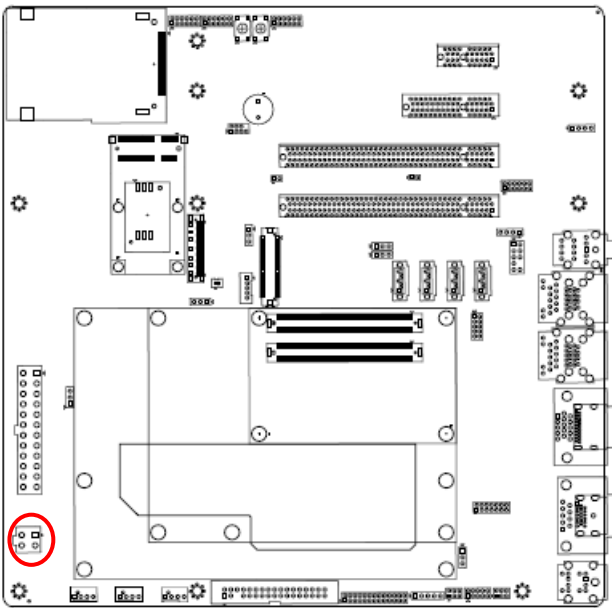

Signal	PIN	PIN	Signal
+12V	3	1	GND
+12V	4	2	GND

2.3.10 CPU Fan connector/ System Fan connector 1/ System Fan connector 2 (C_FAN1/ S_FAN1/ S_FAN2)

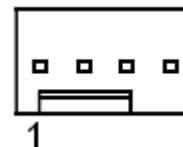
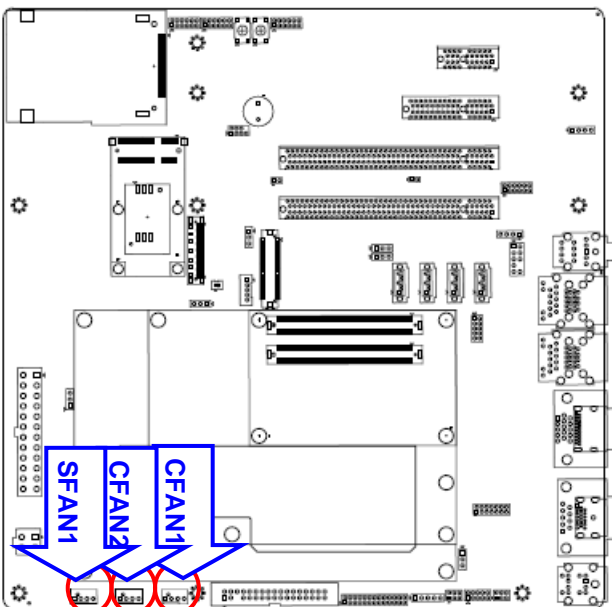

CFAN2

Signal	PIN
GND	1
+12V	2
CPUFANIN1	3
CPUFANOUT1	4

CFAN1

Signal	PIN
GND	1
+12V	2
CPUFANIN	3
CPUFANOUT	4

SFAN1

Signal	PIN
GND	1
+12V	2
SYSFANIN	3
SYSFANOUT	4

2.3.11 Floppy connector 1 (FDC1)

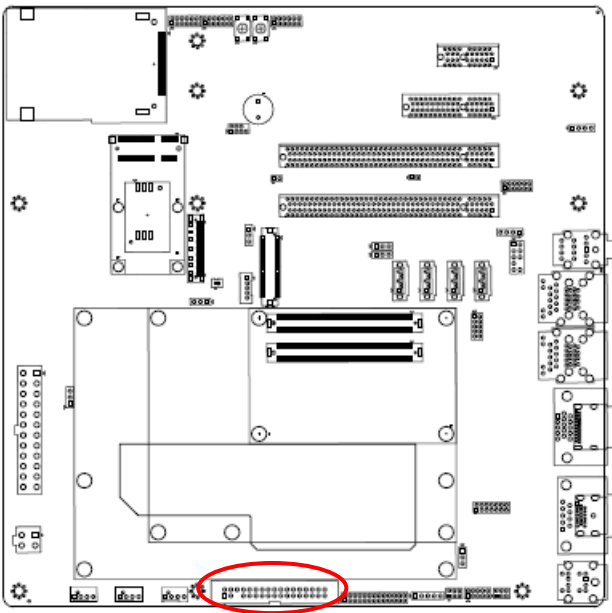

Signal	PIN	PIN	Signal
GND	1	2	DRVDEN0
GND	3	4	NC
		6	NC
GND	7	8	INDEX#
GND	9	10	MOA#
GND	11	12	NC
GND	13	14	DSA#
GND	15	16	NC
GND	17	18	DIR#
GND	19	20	STEP#
GND	21	22	WD#
GND	23	24	WE#
GND	25	26	TRAK0#
GND	27	28	WP#
GND	29	30	RDATA#
GND	31	32	HEAD#
GND	33	34	DSKCHG#

2.3.12 Printer connector (JPRT1)

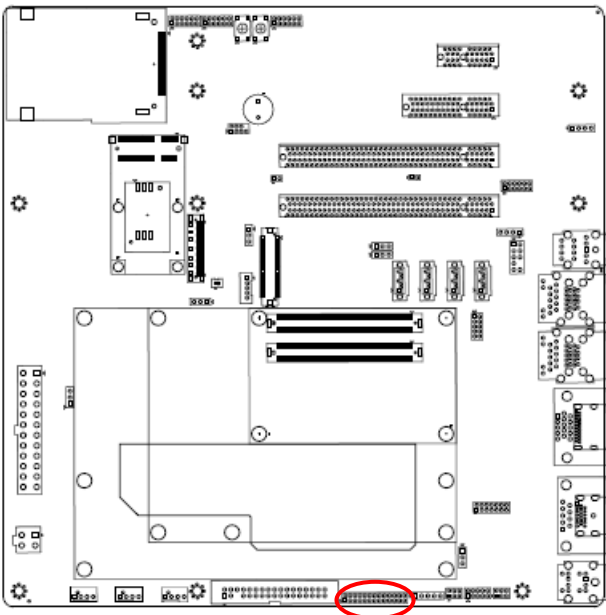

Signal	PIN	PIN	Signal
STB-	1	2	LPT_AFD#
PD0	3	4	LPT_ERR#
PD1	5	6	LPT_INIT#
PD2	7	8	LPT_SLIN#
PD3	9	10	GND
PD4	11	12	GND
PD5	13	14	GND
PD6	15	16	GND
PD7	17	18	GND
LPT_ACT#	19	20	GND
LPT_BUSY	21	22	GND
LPT_PE	23	24	GND
LPT_SLCT	25	26	GND

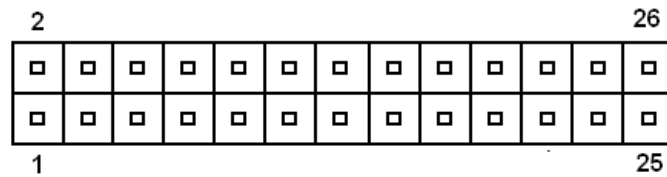

2.3.13 IR connector (JIR1)

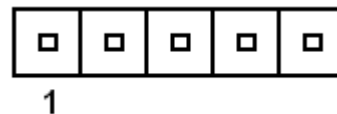
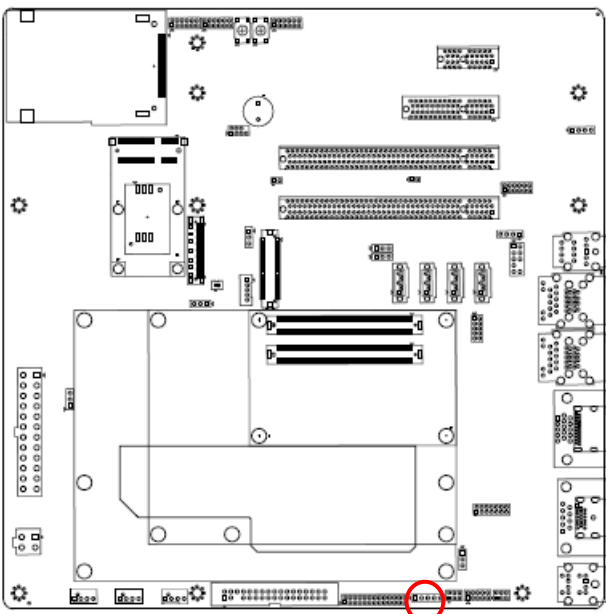

Signal	PIN
+5V	1
NC	2
IRRX	3
GND	4
IRTX	5

2.3.14 Serial Port 2 RS422/485 connector (J422/485)

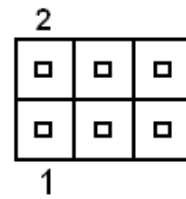
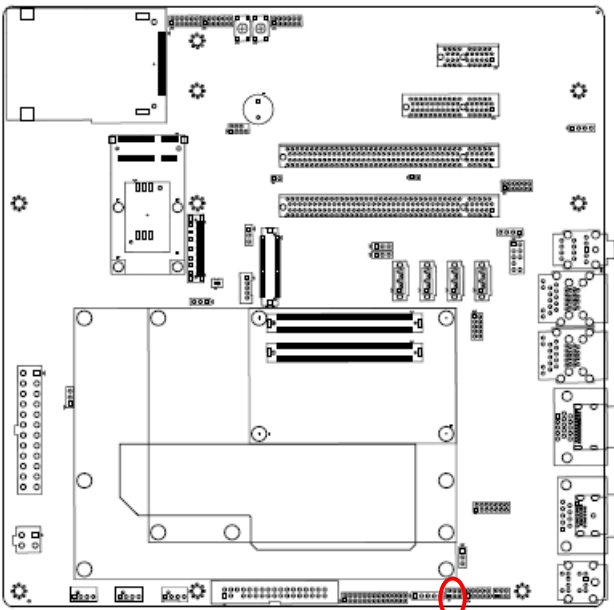

422 Mode

Signal	PIN	PIN	Signal
TX-	1	2	RX-
TX+	3	4	RX+
+5V	5	6	GND

485 Mode

Signal	PIN	PIN	Signal
DATA-	1	2	-
DATA+	3	4	-
+5V	5	6	GND

2.3.15 Serial Port 2 RS232 connector (JCOM2)

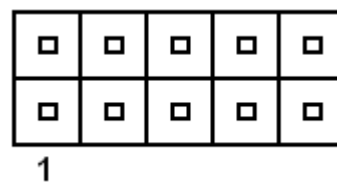
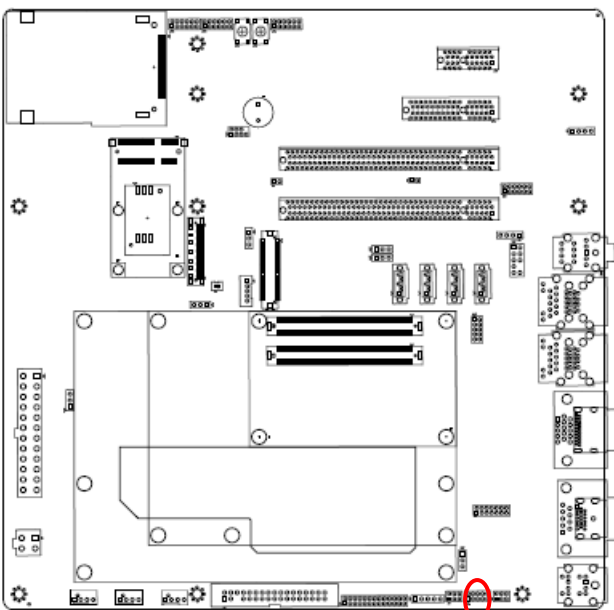

Signal	PIN	PIN	Signal
DCD	1	2	RXDD
TXDD	3	4	DTR
GND	5	6	DSR
RTS	7	8	CTS
RI	9	10	NC

2.3.16 General Purpose I/O connector (JDIO1)

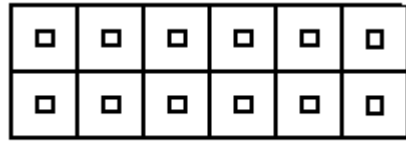
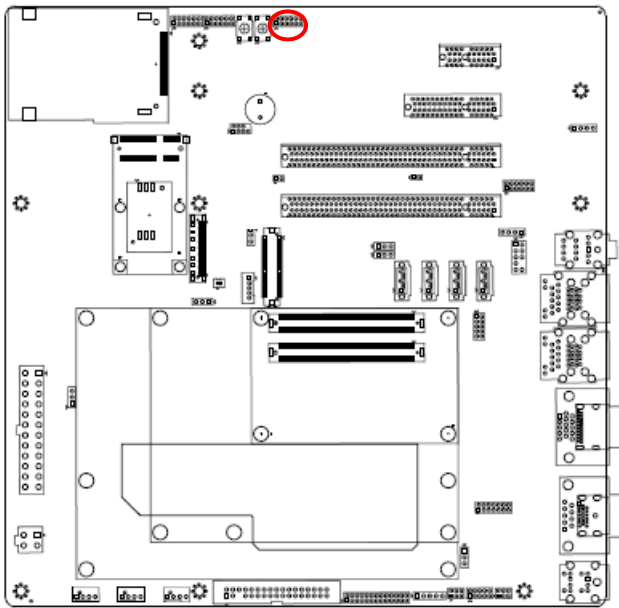

1

Signal	PIN	PIN	Signal
DO0	1	2	DI0
DO1	3	4	DI1
DO2	5	6	DI2
DO3	7	8	DI3
SMB_CLK	9	10	SMB_DAT
GND	11	12	+5V

2.3.17 Multi-purpose connector (JCN3)

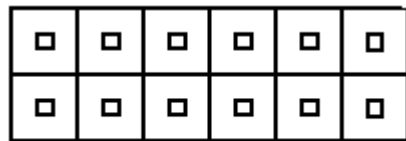
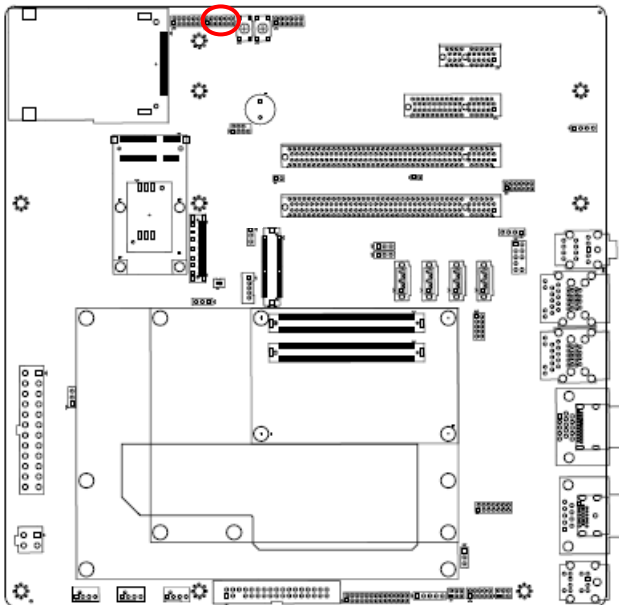

1

Signal	PIN	PIN	Signal
SER0_TX	1	2	SER0_RX
SER1_TX	3	4	SER1_RX
SLEEP#	5	6	GND
LID#	7	8	GND
PP_TPM	9	10	GND
PP_TPM	11	12	+3VSB

2.3.18 Front panel connector (JFP1)

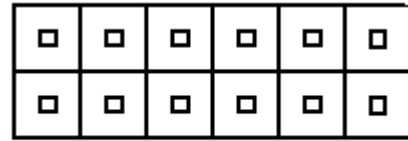
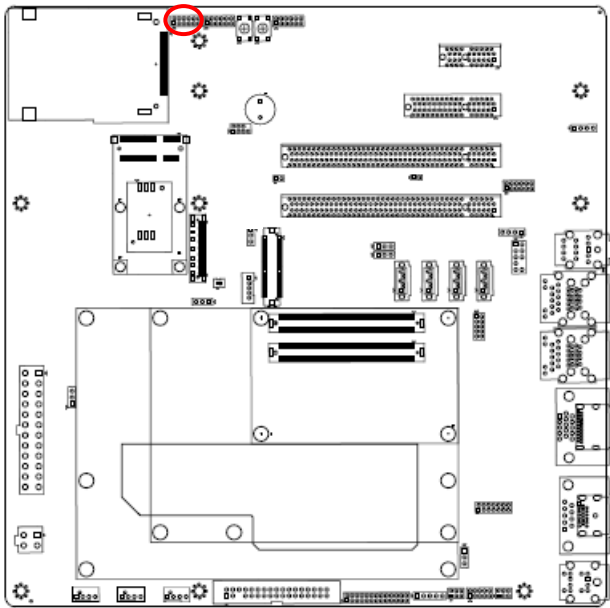

1

Signal	PIN	PIN	Signal
GND	12	11	CASEOPEN#
AT_BN	10	9	EXT_PWRBTN#
SATA_LED#	8	7	+5V
GND	6	5	+5V
GND	4	3	SYS_RERST#
GND	2	1	EXT_PWRBTN#

Pin	1	2	3	4	5	6	7	8	9	10	11	12
Signal	Power Button		Reset		Power LED		HDD LED		Short = AT Open = ATX		Case Open	

2.3.19 SPI selector (JSPI1)

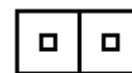
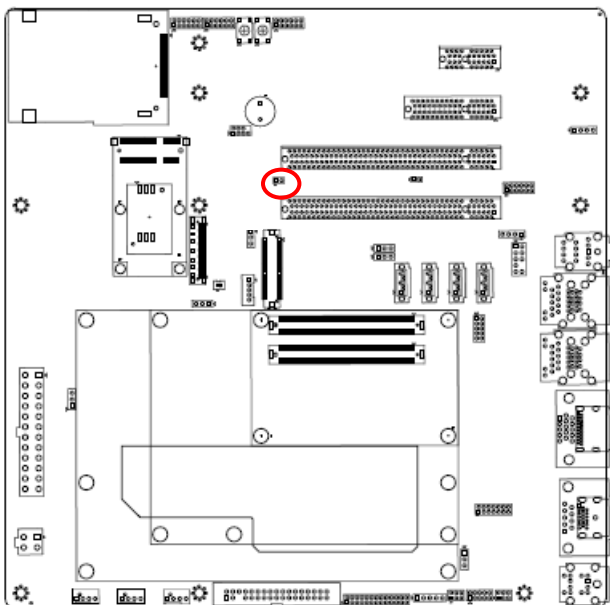

1

Signal	PIN
GND	1
BIOS_DIS1#	2

Note:

jumper 1-2 closed can disable module board SPI FLASH , use carrier board SPI FLASH

2.3.20 Carrier board SPI FLASH programming (JSPI2)

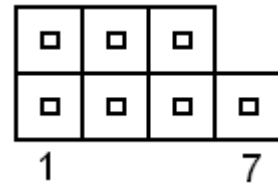
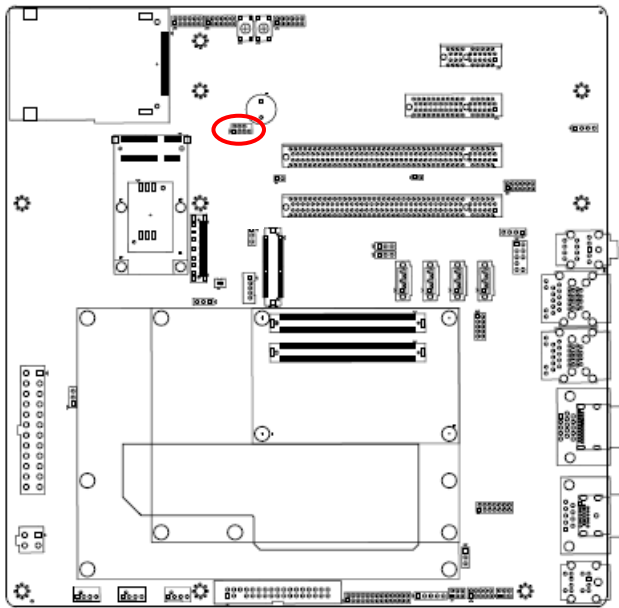

Signal	PIN	PIN	Signal
+3VSB	1	2	GND
SPI_CS#	3	4	SPI_CLK
SPI_MOSI	5	6	SPI_MISO
SPI_HOLD#	7		

2.3.21 LCD backlight brightness adjustment connector (JVR1)

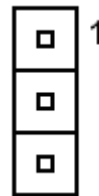
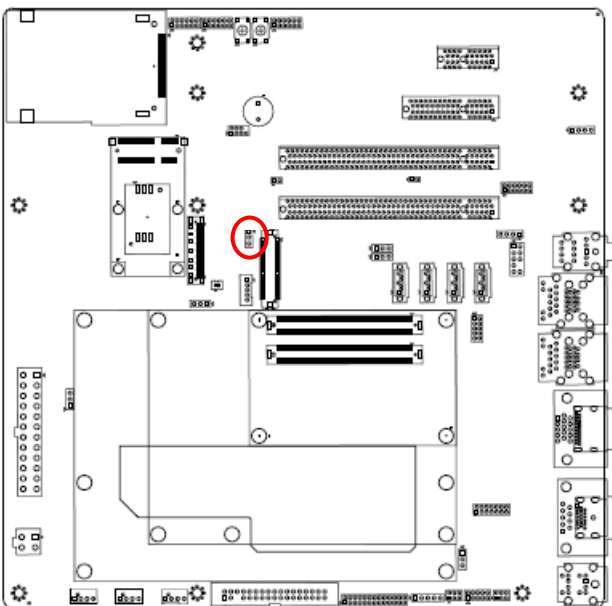

Signal	PI N
+5V	1
LVDS_BKLT_CTRL	2
GND	3

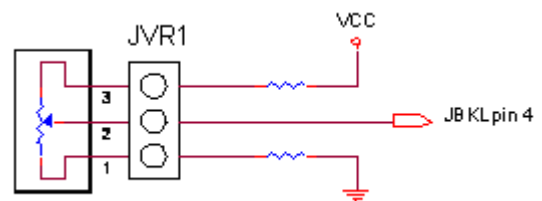

Variation Resistor
(Recommended: 4.7KΩ, >1/16W)

2.3.22 LCD Inverter connector (JBKL1)

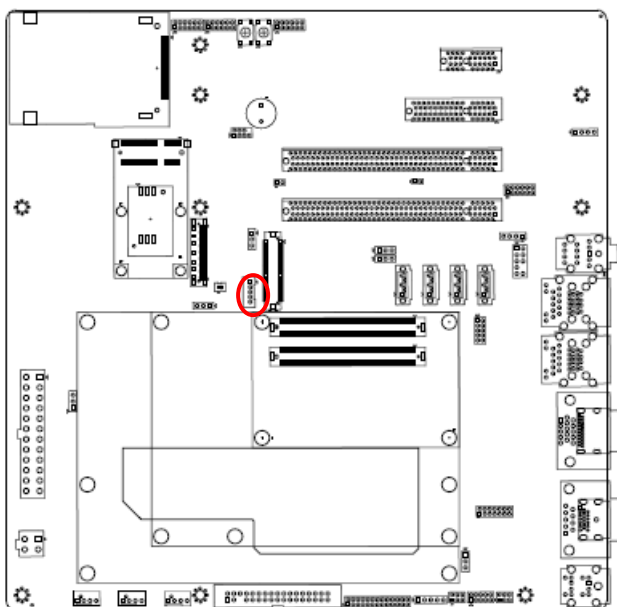

Signal	PIN
+12V_BKL	1
GND	2
BKLEN	3
LVDS_BKLT_CTRL/PWM	4
+5V	5



Note:

For inverter with brightness control function through LVDS_BKLT_CTRL/PWM signal (Pin-4) , it is possible to control the brightness level by carrier board's JVR1 pin2. In this case, R179 would be removed to disconnect the PWM control signal from COMExpress module (CN1A Pin-B84).

2.3.22.1 Signal Description – LCD Inverter connector (JBKL1)

Signal	Signal Description
LVDS_BKLT_CTRL	when LVDS_BKLT_CTRL is controlled by carrier board's JVR1, $V_{adj} = 0.75V \sim 4.25V$ (Recommended: $4.7K\Omega, >1/16W$)
BKLEN	LCD backlight ON/OFF control signal

EEV-EX14 User's Manual

2.3.23 LVDS connector (LVDS1)

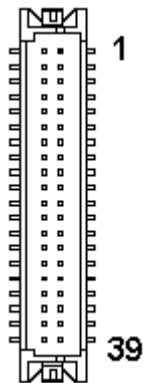
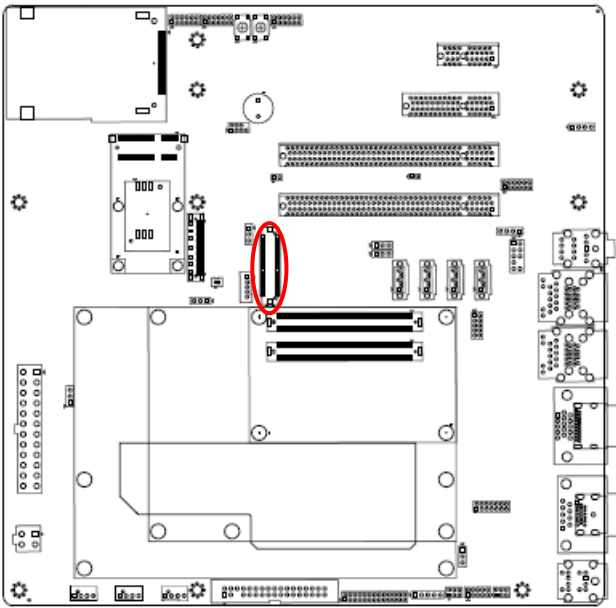

Signal	PIN	PIN	Signal
+5V	2	1	+3.3V
+5V	4	3	+3.3V
LVDS_DDC_SD	6	5	LVDS_DDC_SC
GND	8	7	GND
LVDSA_DATA0	10	9	LVDSA_DATA1
LVDSA_DATA0#	12	11	LVDSA_DATA1#
GND	14	13	GND
LVDSA_DATA2	16	15	LVDSA_DATA3
LVDSA_DATA2#	18	17	LVDSA_DATA3#
GND	20	19	GND
LVDSB_DATA0	22	21	LVDSB_DATA1
LVDSB_DATA0#	24	23	LVDSB_DATA1#
GND	26	25	GND
LVDSB_DATA2	28	27	LVDSB_DATA3
LVDSB_DATA2#	30	29	LVDSB_DATA3#
GND	32	31	GND
LVDSA_CLK	34	33	LVDSB_CLK
LVDSA_CLK#	36	35	LVDSB_CLK#
GND	38	37	GND
+12V	40	39	+12V

2.3.24 USB Connector 4 & 5 (JUSB1)

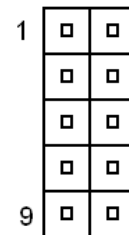
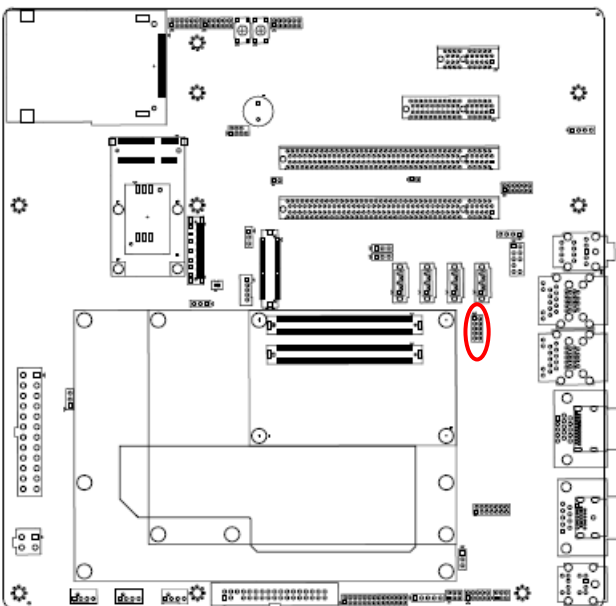

Signal	PIN	PIN	Signal
+5V	1	2	GND
D4-	3	4	GND
D4+	5	6	D5+
GND	7	8	D5-
GND	9	10	+5V

2.3.25 LPC port connector (JLPC1)

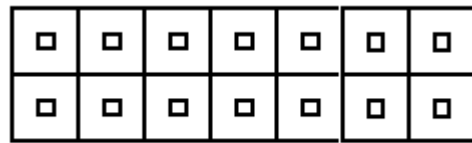
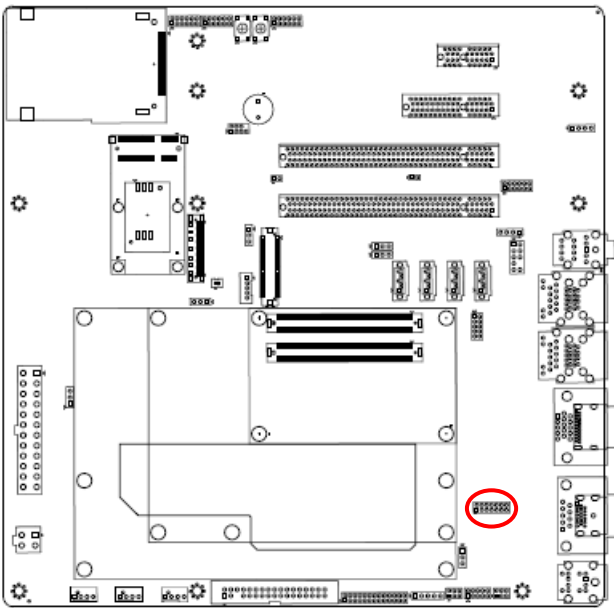

1

Signal	PIN	PIN	Signal
AD0	1	2	+3.3V
AD1	3	4	RESET#
AD2	5	6	FRAME#
AD3	7	8	CLOCK
SERIRQ	9	10	GND
+5V	11	12	GND
+5VSB	13	14	LPC_DRQ1#

2.3.26 SPDIF connector (JSPDIF1)

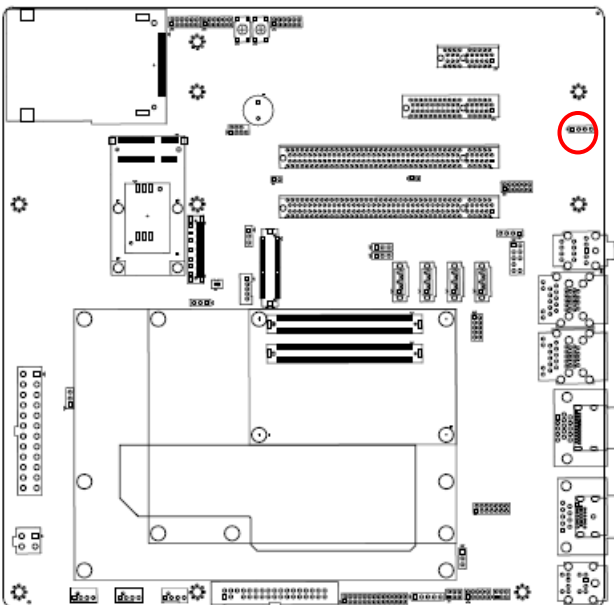

1

Signal	PIN
+3.3V	1
S/PDIF-IN	2
S/PDIF-OUT	3
GND	4

2.3.27 CD-ROM Audio Input connector (JCD1)

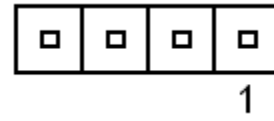
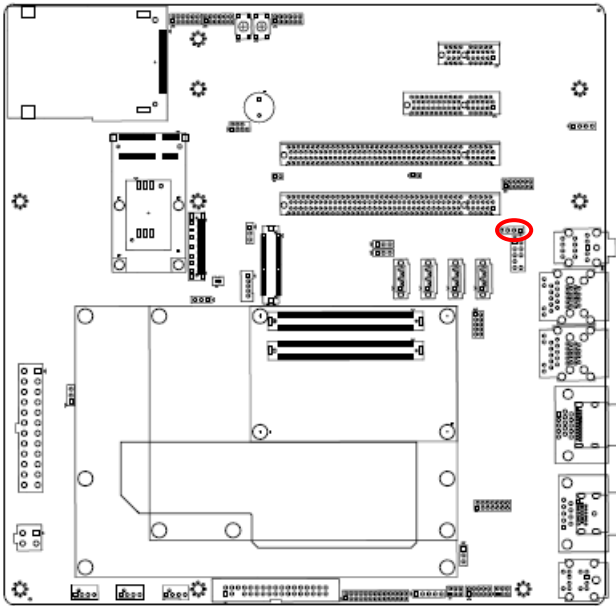

Signal	PIN
CD_L	4
GND	3
GND	2
CD_R	1

2.3.28 7.1ch Audio connector (JAUDIO1)

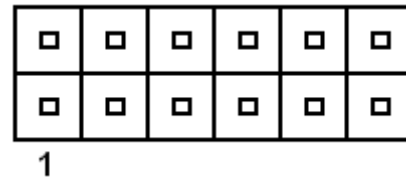
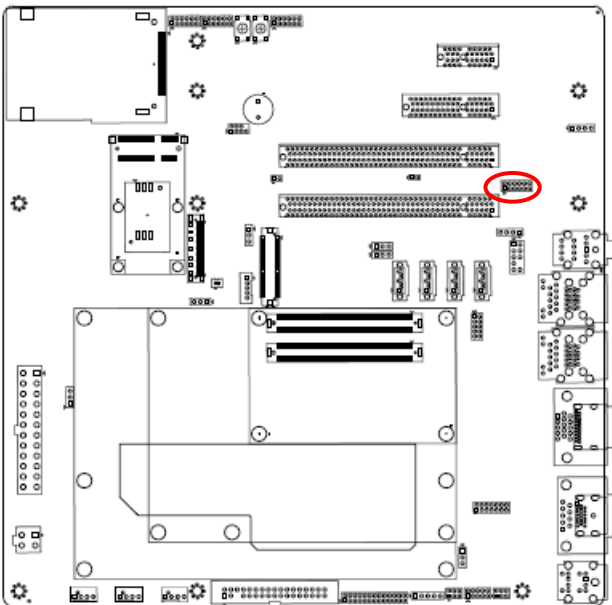

Signal	PI N	PI N	Signal
LFE-OUT	1	2	CEN-OUT
GND	3	4	GND
SURR-R-OUT	5	6	SURR-L-OUT
SIDESURR-R-OU T	7	8	SIDESURR-L-OU T
CEN-JD	9	10	SURR-JD
SIDESURR-JD	11	12	GND

Note :

Pin to pin to the Audio Expansion Card KJAUDIO2 connector

2.3.29 Front Audio connector (JAUDIO2)

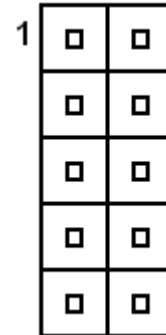
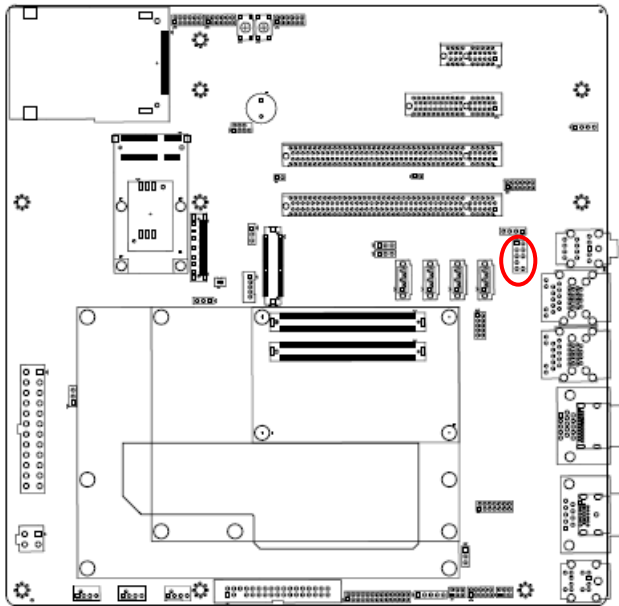

Signal	PIN	PIN	Signal
MIC2-L-IN	1	2	GND
MIC2-R-IN	3	4	ACZ_DET#
LINE2-R-OUT	5	6	MIC2_JD
GND	7		
LINE2-L-OUT	9	10	LINE2-JD

Note :

Pin to pin to the Audio Expansion Card KJAUDIO1 connector

2.3.30 Battery connector (BH1)

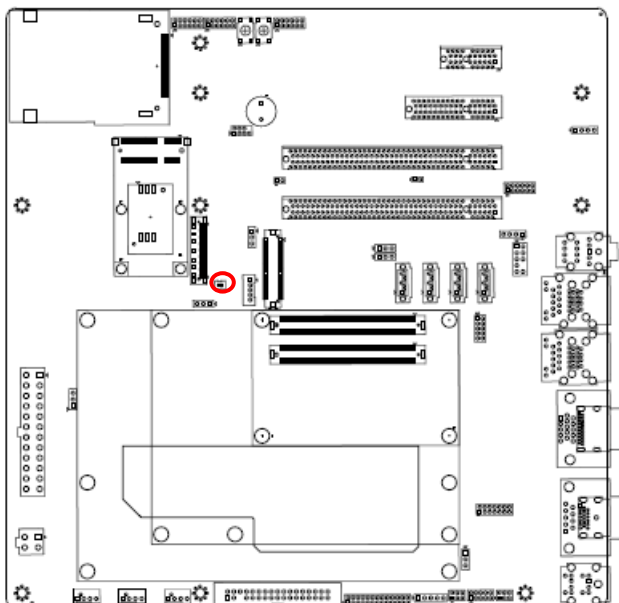

Signal	PIN
+3.3VSB	1
GND	2

2.3.31 EDP connector (EDP1)

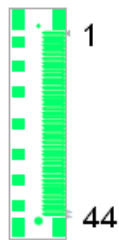
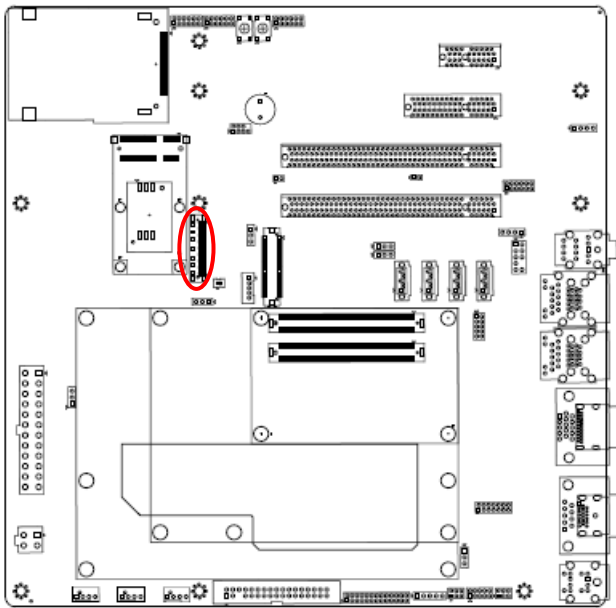

Signal	PIN
+VDD_EDP	1
+VDD_EDP	2
+VDD_EDP	3
+VDD_EDP	4
+VDD_EDP	5
GND	6
GND	7
GND	8
GND	9
EMB_HPDP	10
NC	11
NC	12

Signal	PIN
GND	13
EDP_TX3#	14
EDP_TX3	15
GND	16
EDP_TX2#	17
EDP_TX2	18
GND	19
EDP_TX1#	20
EDP_TX1	21
GND	22
EDP_TX0#	23
EDP_TX0	24
GND	25
EDP_AUX	26
EDP_AUX#	27
GND	28
+3.3V	29
NC	30
+12V	31
GND	32
GND	33
+5V	34
EDP_AUX	35
EDP_BRIGHT_CTRL	36
LVDS_BKLT_EN/ EDP_BKLT_EN	37
GND	38
+3.3V	39
GND	40
SMB_THRM_CLK	41
SMB_THRM_DATA	42
ALS_INTR#	43
TP_VDD_LPP	44

2.4 EEV-EX14 Expansion Boards

2.4.1 Product Overview

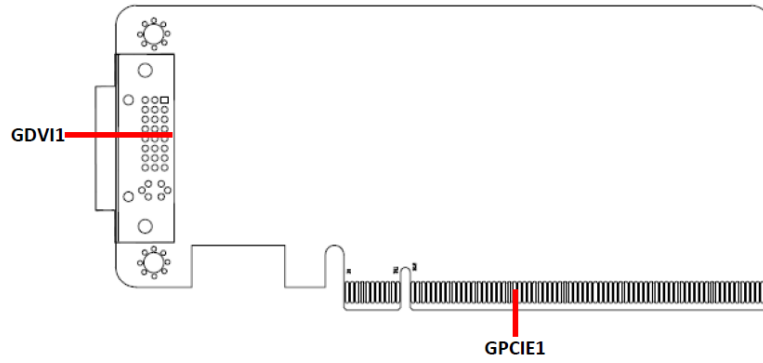

Digital Display Interface Card

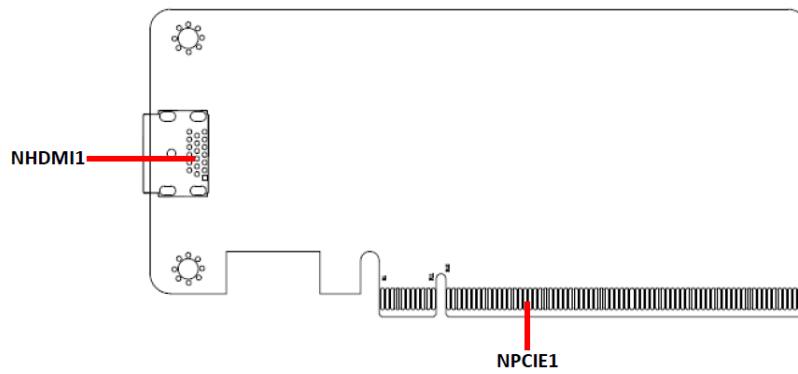

HDMI Level Shift Riser Card

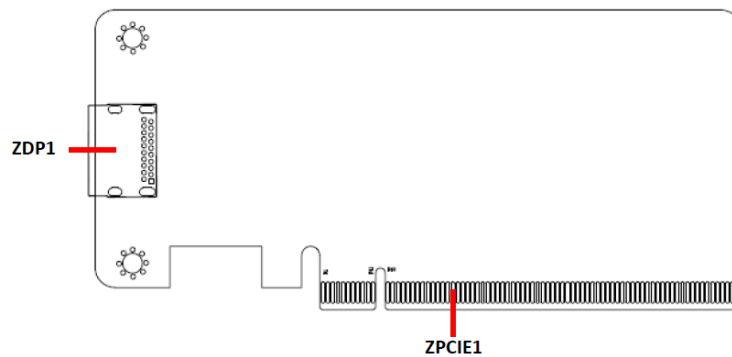

Display Port Riser Card

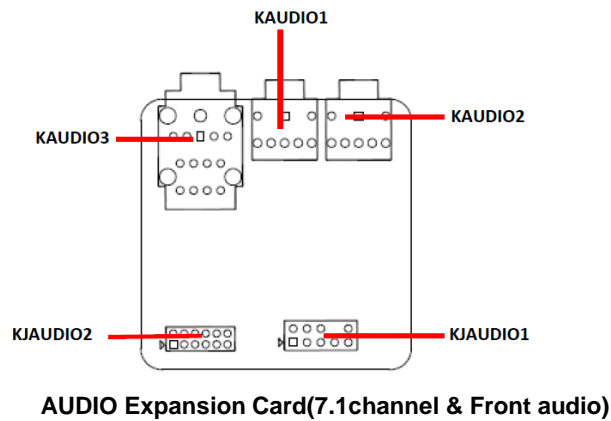

2.4.2 Jumper and Connector List

Connectors

Label	Function	Note
GDVI1	DVI connector	
GPCIE1	PCIE connector (into the PCIE2)	PCIEXPRESS_164V
NHDMI1	HDMI connector	
NPCIE1	PCIE connector(into the PCIE2)	PCIEXPRESS_164V
ZDP1	Display port connector	
ZPCIE1	PCIE connector (into the PCIE2)	PCIEXPRESS_164V
KAUDIO1	Audio connector 1	Jack
KAUDIO2	Audio connector 2	Jack
KAUDIO3	Audio connector 3	Jack
KJAUDIO1	Audio Expansion Card for Front Audio	5x 2 header, pitch 2.54mm
KJAUDIO2	Audio Expansion Card for 7.1ch Audio	6x 2 header, pitch 2.00mm

2.5 EEV-EX14 Expansion Boards Setting

2.5.1 Audio Expansion Card for Front Audio (KJAUDIO1)

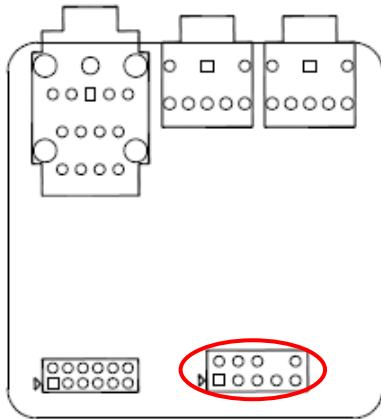

**AUDIO Expansion Card
(7.1channel & Front audio)**

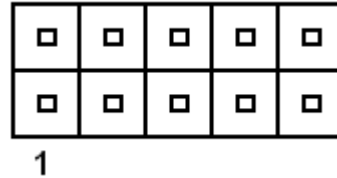

Signal	PIN	PIN	Signal
MIC2-L-IN	1	2	GND
MIC2-R-IN	3	4	ACZ_DET#
LINE2-R-OUT	5	6	MIC2_JD
GND	7		
LINE2-L-OUT	9	10	LINE2-JD

2.5.2 Audio Expansion Card for 7.1ch Audio (KJAUDIO2)

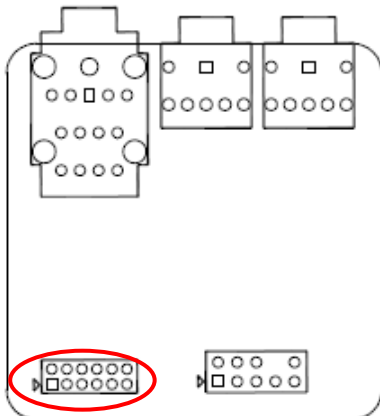

**AUDIO Expansion Card
(7.1channel & Front audio)**

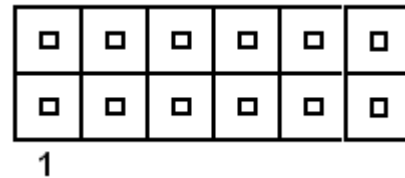

Signal	PIN	PIN	Signal
LFE-OUT	1	2	CEN-OUT
GND	3	4	GND
SURR-R-OUT	5	6	SURR-L-OUT
SIDESURR-R-OUT	7	8	SIDESURR-L-OUT
CEN-JD	9	10	SURR-JD
SIDESURR-JD	11	12	GND

